



JØTUL[®]

Stoves and Fireplaces



New Season Brochure





JØTUL®

Jøtul is the longest running producer of wood stoves in the world boasting a 160 year long history. The adventure started in Loelva in 1853 where Oluf Onsum the son of a farmer, founded Kværner Jernstøberi. Kværner started the development of cast iron products, and leading up to 1900, the company was one of the largest wood stove foundries in Norway. Today Jøtul products can be found all over the world and are providing Australian families beautiful warmth season after season.





Jøtul F 100  **JØTUL**

Front

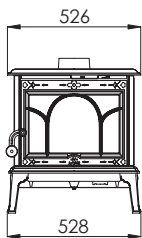

Side

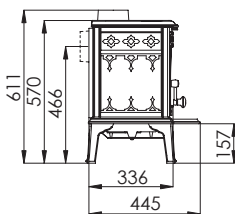

From above

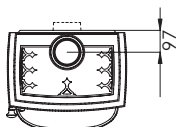

The F 100 is small in footprint but big in performance. The attractive pattern in the cast iron and up to 7kW peak output in thermal performance means that the stove makes its presence known in every room, both aesthetically and temperature-wise. Despite the small size of the stove, it has a big glass door that gives a good view of the fire.



COLOUR ● MATT BLACK





JØTUL Jøtul F 163

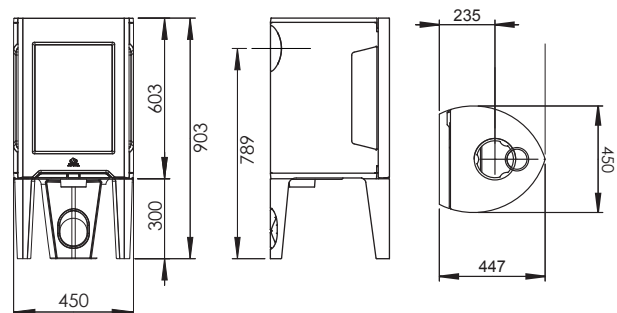

F 163 is characterised by its large side glasses and three sturdy legs that give the wood stove an easy and modern look, which makes it suitable for both corner and standard installations. Designed to suit modern living and powerful enough to heat 100-140m².

- COLOURS
- MATT BLACK
 - WHITE ENAMEL



red dot design award
winner 2015



reddot design award
winner 2011

Jøtul F 305 LL
Jøtul F 305 B **JØTUL**



Jøtul F 305 series has a horizontal design that makes it easy to place logs and provides a rapid 10kW peak heat transfer to the room. Integrated convection has an impressive 1g/kg emission rate. With Norwegian designers Anderssen & Voll, we have made a stove which merges 160 years of heating experience with timeless design. Available with Long Legs (LL) or wood stacker base (B).

- COLOURS
- MATT BLACK
 - WHITE ENAMEL (LL model only)

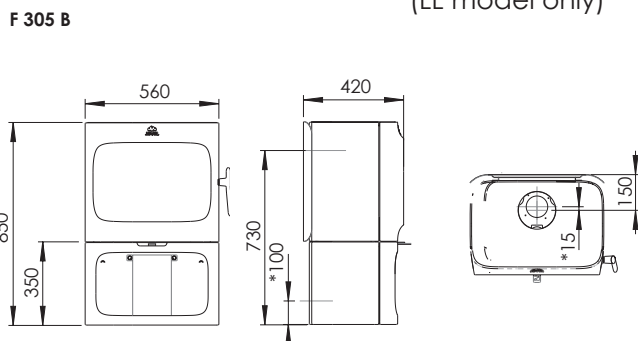
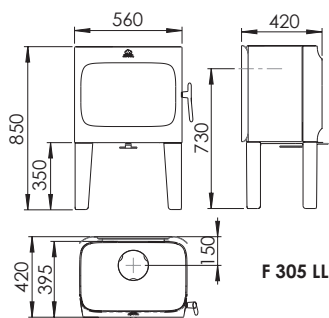





JØTUL Jøtul F 520

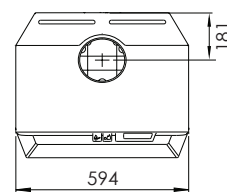
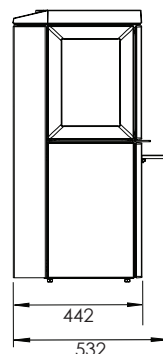
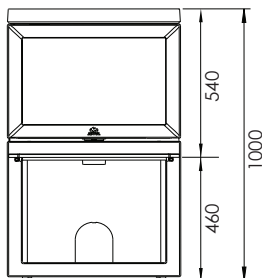

With panoramic view to the fire, the 13kW peak F 520 offers an experience of a live campfire in your living room. With its wide expanse of glass, flames can be fully enjoyed from three sides of the stove. An innovative special glass coating means the glass stays clean. The smart construction of the air valves makes the stove easy to light and is user friendly.

COLOUR ● MATT BLACK





Jøtul F 3 

Front

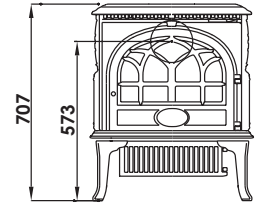

Side

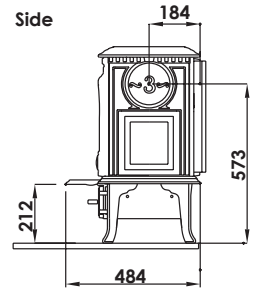

From above

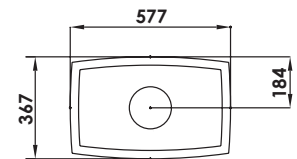

Jøtul F3 CB has advanced clean burn technology for greater efficiency and an integral ash solution. It can also burn selected smokeless fuels without the need for an adaption kit. Adaptable with a short leg option, the Jøtul F3 makes an elegant focal point in any room, and gives a peak heat output up to 12kW.

COLOURS

 BLUE BLACK ENAMEL

 IVORY ENAMEL



Jøtul F3 TD is a medium sized stove that has a classic design, with a large glass door which gives a fantastic view of the flames.

*rear heat shield is optional if installing next to a non-combustible wall

COLOUR

 MATT BLACK



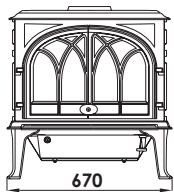

JØTUL Jøtul F 400

Front

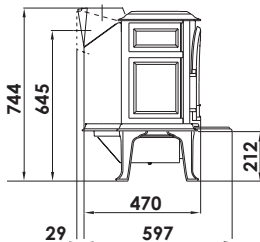

Side



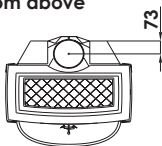

From above



Jøtul F 400 is a solid cast iron wood stove that has an impressive 11kW average heat output. Designed with the clean burn system to ensure that you get the maximum energy out of your wood. With an unique, delicate design on both sides and top makes this stunning heater a decorative feature perfect for any home.

COLOURS

-  MATT BLACK
-  BLUE BLACK ENAMEL
-  IVORY ENAMEL



*SE door available in all colours and Lattice door only available in matt black.



Jøtul F 8



Front

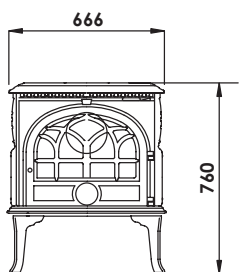

Side

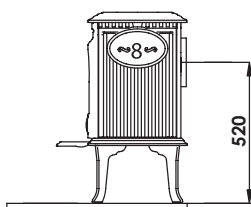

From above

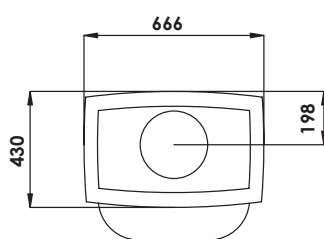

The Jøtul F 8 is one of Jøtul's oldest traditional stoves still going strong. Why have people warmed to this stove for generations? Perhaps it's the timeless, classic look, combined with an impressive peak heat output of 17kW.

COLOURS

● MATT BLACK





		F100	F163	F 3 CB	F 3 TD	F 305 LL	F 305 B	F 400	F 520	F 8
Output (kilowatts)	Peak	7	9	12	13	10	10	12	13	17
	Ave	7	8	11	11	9	9	11	11	15
Emissions	g/kg	1.4	1.5	1.2	1.0	1	1	1.1	1.4	0.9
Efficiency (%)	Peak	80	70	68	73	72	72	69	73	74
	Ave	75	65	64	66	64	64	68	65	71
Coverage	m ²	80 - 120	100 - 140	130 - 150	100 - 120	110 - 130	110 - 130	130 - 150	120 - 140	150 - 180
Weight	kg	97	115	124	106	143	169	158	170	115
Log size (max)	mm	400	330	400	400	410	410	500	500	480

Installation Clearances (mm)

MODEL	REAR HEATSHIELD	FLUE REQUIRED 150mm (6") WITH	REAR	SIDE	CORNER	FRONT	HEARTH
F100	YES	Decromesh with 900mm flue shield	300	500	400	300	6mm thermal sheet
F 163	NO	900mm flue shield	200	650	500	300	6mm thermal sheet
F 3 CB	YES	Decromesh with 900mm flue shield	150	450	325	300	6mm thermal sheet
		900mm flue shield	350	450	325	300	
F 3 TD	YES	900mm flue shield	250	850	600	450	15mm thermal sheet
F305 LL F 305 B	YES	900mm flue shield	200	400	250	300	6mm thermal sheet
	YES	250mm solid with DLR 150	200	400	250	300	
F 400	YES	Decromesh with 900mm flue shield	250	500	500	300	6mm thermal sheet
F 520	NO	900mm flue shield					
		200mm solid with DLR 150 [^]	200	650	400	300	6mm thermal sheet
F 8	YES	Decromesh with 900mm flue shield	200	600	600	350	2 x 12mm thermal sheet with 0.5mm steel sheet between

[^] DLR, is a locating ring around the flue spigot that the 200mm solid flue sits in. It also assists with the required ventilation.

Traditional Matt Black Paint – F 163, F 400, F 3 TD, F 100, F 8, F 520, F 305 B, F 305 LL

Blue Black Enamel Finish – F 3, F 400

Ivory Enamel Finish – F 3, F 400

White Enamel Finish – F 163, F 305 LL

The information and colours represented in this brochure should be used as a guide only.

All measurements are in millimeters (mm) unless otherwise stated.

In the interest of product development for hardwood burning, Glen Dimplex Australia reserves the right to alter or change the product specifications stated in the document without prior notice.



Contact local building or fire officials regarding restrictions and installation inspection requirements in your area.

Our 10 year limited warranty: A Cast-Iron promise of quality.

Jøtul guarantees the quality of its wood stoves against any defects in materials or workmanship for 10 years, subject to the exclusions and limitations noted on our warranty. For complete details, ask your authorised Jøtul dealer. Always refer to your Jøtul Operating Instructions for specific information regarding how to use your Jøtul.



Australian Importer & Distributor



Glen Dimplex Australia Pty Ltd
8 Lakeview Drive,
Scoresby Victoria 3179
T 1300 554 155
flame@glendimplex.com.au